

Verona 5 Drawer Chest – Wall Fixing Guide

IMPORTANT READ CAREFULLY – RETAIN FOR FUTURE REFERENCE

Thank you for buying the Verona 5 Drawer Chest

- Please take a few quiet minutes to read these instructions

PRODUCT SAFETY

- Feather & Black strongly advise using the Anti-Tip wall fixings provided with this product however the wall fixing itself may need to be altered depending on your wall. If this fixings have been misplaced please contact our customer service team who will be more than happy to send you a replacement kit

PRODUCT CARE

- Wipe clean using a soft damp cloth followed by dry cloth
- Do not use abrasives or cleaning product which may contain ammonia or solvents
- Take care when handling or moving the furniture. Careless handling can damage wooden furniture, try to lift rather than drag
- Do not jump or stand on product

WALL FIXING INSTRUCTIONS

VERONA 5 DRAWER CHEST

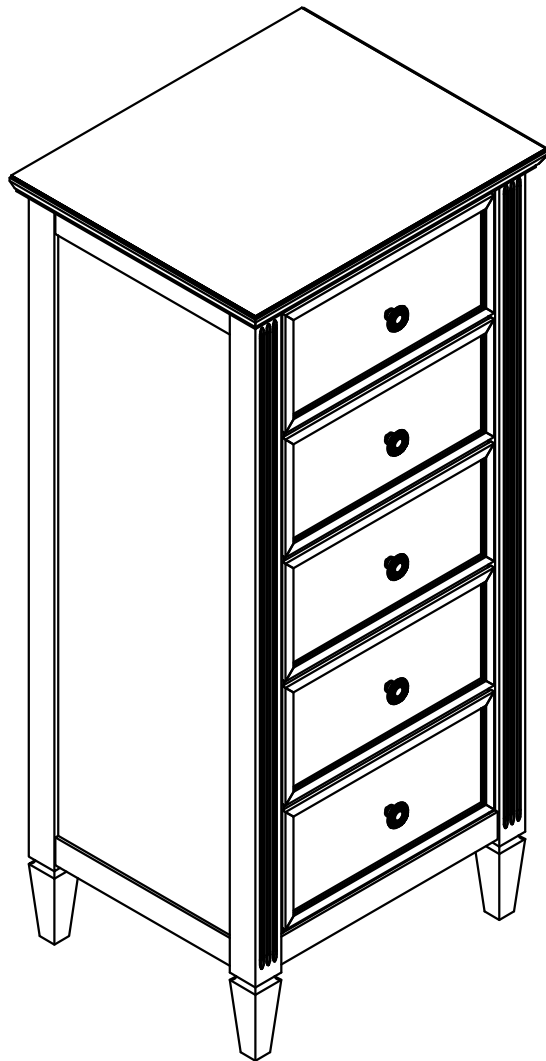

Hardware and Wall Fixing Packs

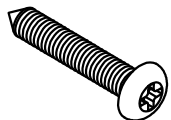

Strap Fixing Screw

(A) = 1 pc



Strap Fixing Washer

(B) = 1 pc



Strap

(C) = 1 pc

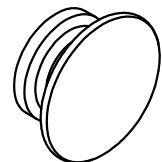

Optional Painted Handle

5 pcs

WALL FIXING INSTRUCTIONS

VERONA 5 DRAWER CHEST

1

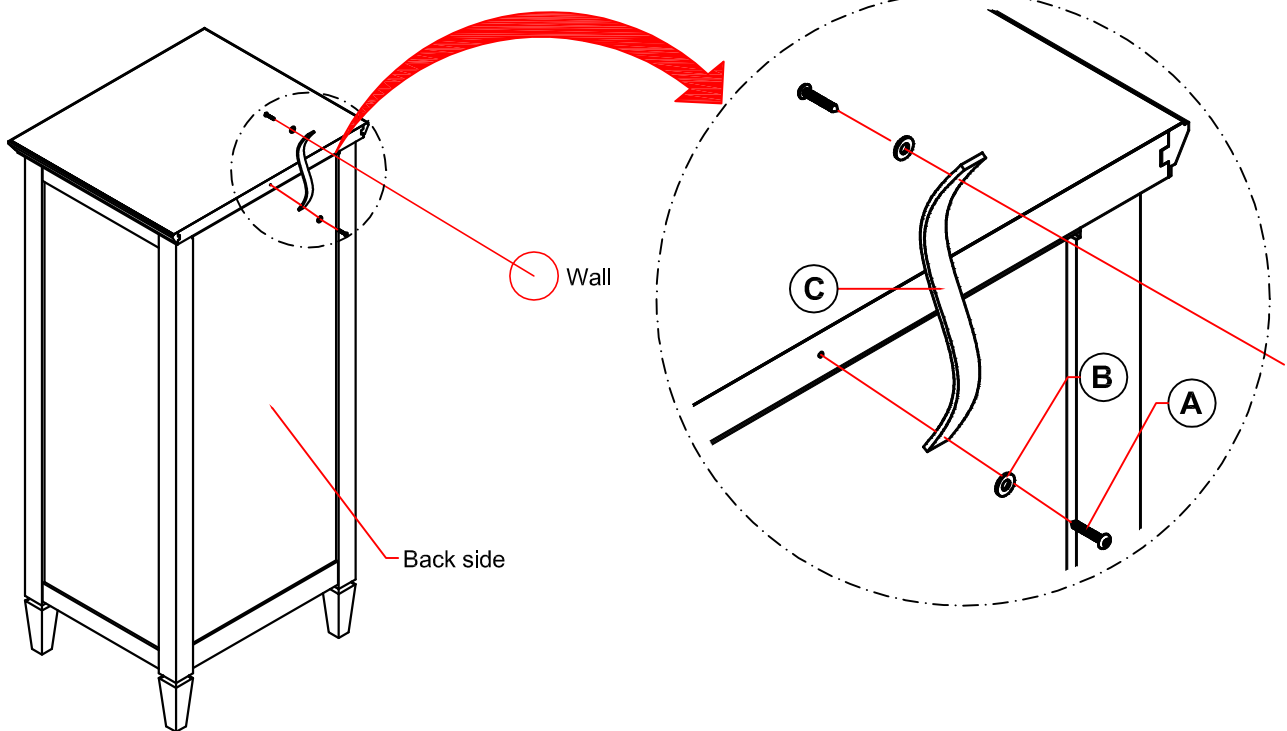

To avoid any risk of tipping, it is recommended to secure this unit to the wall as below instruction guide
Due to different wall types, fixing NOT included

Wall Fixing - if in doubt seek professional advice

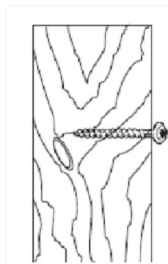

Wood

If fixing to wood make sure that it isn't chipboard as screws can easily pull away from the core structure

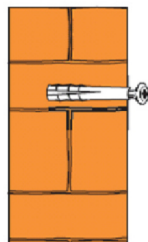

Brick or Masonry

Use an appropriate wall plug provided you are sure your wall is sound

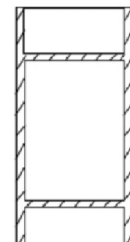

Cavity Wall

Special toggle wall plugs are needed. Seek expert advice