

# feather&black

Perfect Bedtimes

## Verona 2+2 Drawer Chest – Wall Fixing Guide

**IMPORTANT READ CAREFULLY – RETAIN FOR FUTURE REFERENCE**

**Thank you for buying the Verona 2+2 Drawer Chest**

- Please take a few quiet minutes to read these instructions

### **PRODUCT SAFETY**

- Feather & Black strongly advise using the Anti-Tip wall fixings provided with this product however the wall fixing itself may need to be altered depending on your wall. If this fixings have been misplaced please contact our customer service team who will be more than happy to send you a replacement kit

### **PRODUCT CARE**

- Wipe clean using a soft damp cloth followed by dry cloth
- Do not use abrasives or cleaning product which may contain ammonia or solvents
- Take care when handling or moving the furniture. Careless handling can damage wooden furniture, try to lift rather than drag
- Do not jump or stand on product

Contact Detail Customer Service Centre  
(01243)380 600  
[sales@featherandblack.com](mailto:sales@featherandblack.com)  
[www.featherandblack.com](http://www.featherandblack.com)

# WALL FIXING INSTRUCTIONS

## VERONA 2+2 DRAWER CHEST

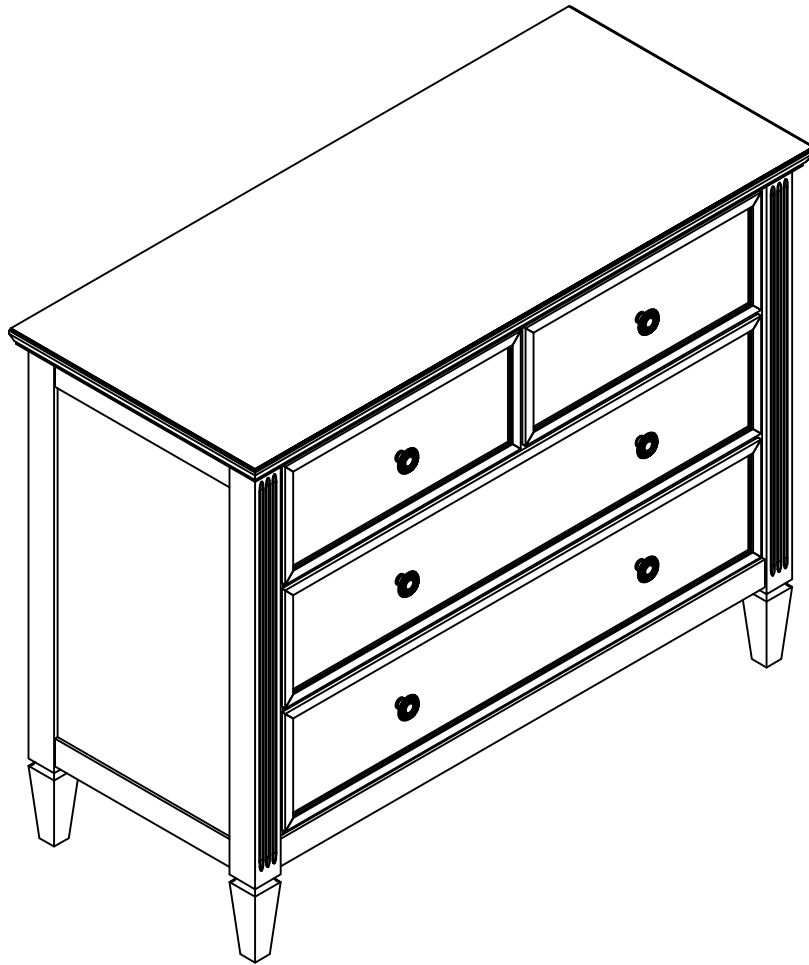

### Hardware and Wall Fixing Packs

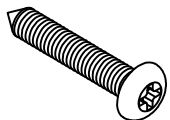

Strap Fixing Screw

**(A) = 1 pc**



Strap Fixing Washer

**(B) = 1 pc**



Strap

**(C) = 1 pc**

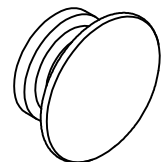

Optional Painted Handle

**6 pcs**

# WALL FIXING INSTRUCTIONS

## VERONA 2+2 DRAWER CHEST

1

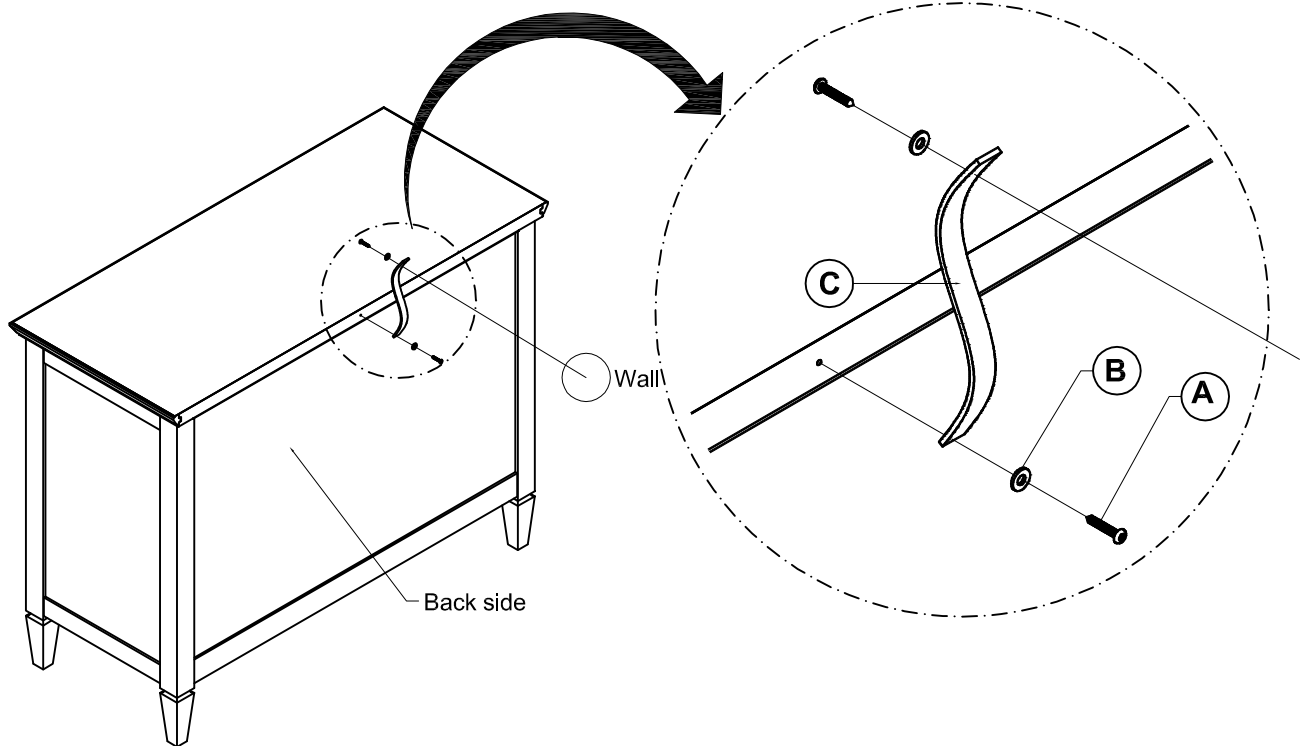

To avoid any risk of tipping, it is recommended to secure this unit to the wall as below instruction guide  
Due to different wall types, fixing NOT included

Wall Fixing - if in doubt seek professional advice

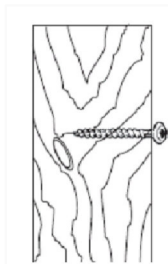

### Wood

If fixing to wood make sure that it isn't chipboard as screws can easily pull away from the core structure

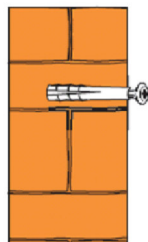

### Brick or Masonry

Use an appropriate wall plug provided you are sure your wall is sound

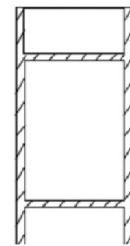

### Cavity Wall

Special toggle wall plugs are needed. Seek expert advice