

feather & black











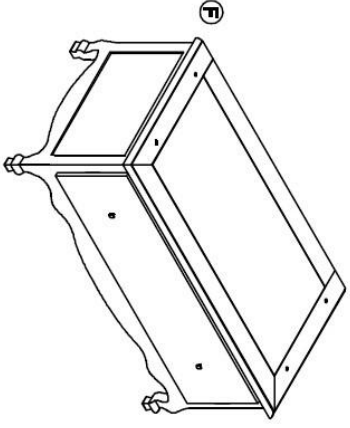

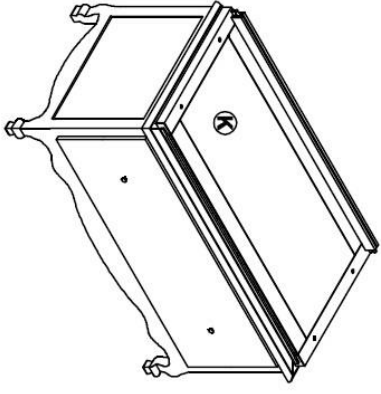

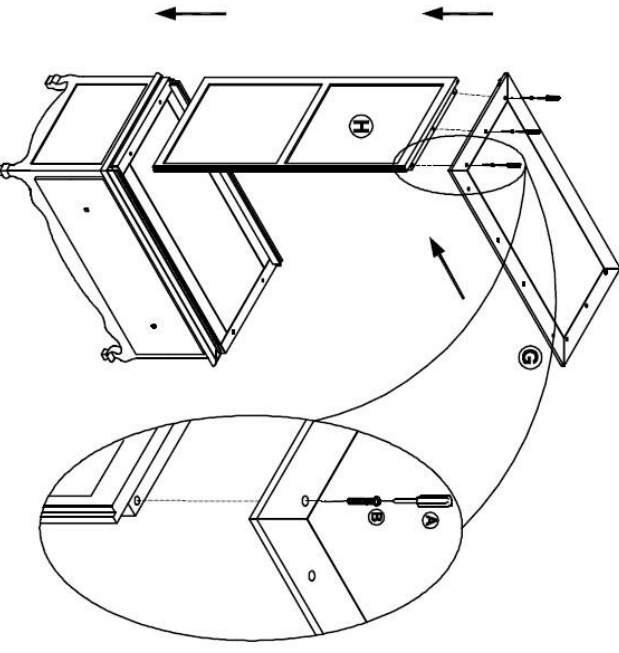
Sienna Wardrobe

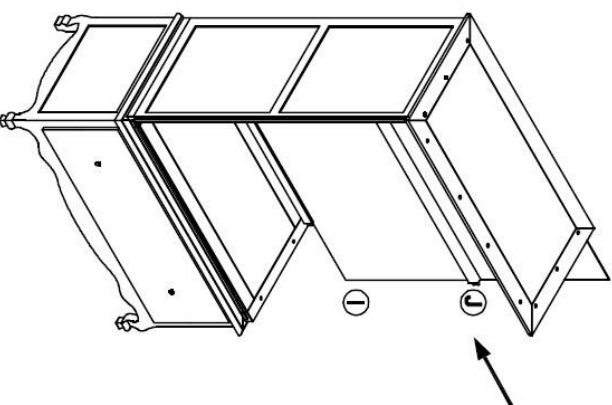
IMPORTANT READ CAREFULLY – RETAIN FOR FUTURE REFERENCE

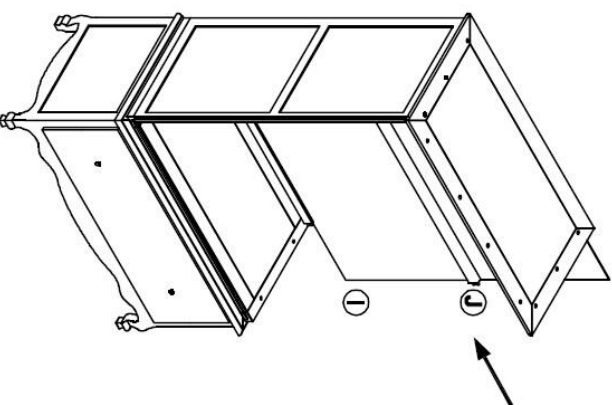
Thank you for buying the Sienna Wardrobe

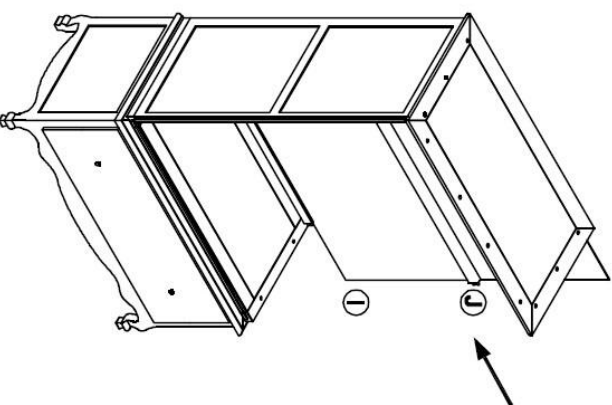
PRODUCT CARE

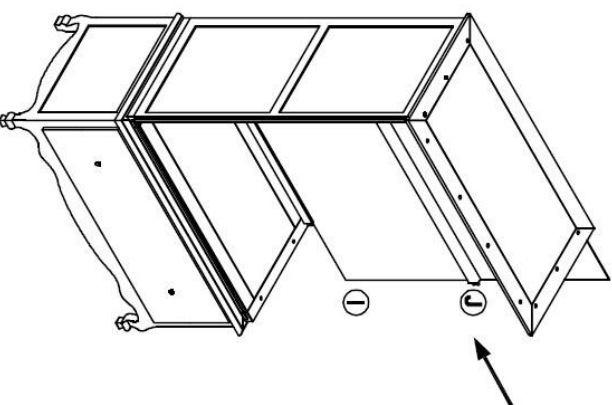
- Wipe clean using a soft damp cloth followed by dry cloth
- Do not use abrasives or cleaning products which may contain ammonia or solvents
- Take care when handling or moving the furniture. Careless handling can damage wooden furniture, try to lift rather than drag
- The fabric is dry clean only and spot clean only

PARTS	Q'TY	
A  M6	1PCS	<p>1</p> 
B  25/16" * 30mm	28PCS	
B1  25/16" * 70mm	4PCS	<p>2</p> 
D  24 * 16mm	4PCS	
E 	2PCS	<p>3</p> 
F 	1PCS	
G 	1PCS	<p>4</p> 
H 	2PCS	
I 	1PCS	<p>5</p> 
J 	1PCS	
K 	1PCS	<p>6</p> 
L 	1PCS	
M 	4PCS	<p>7</p> 
N 	1PCS	

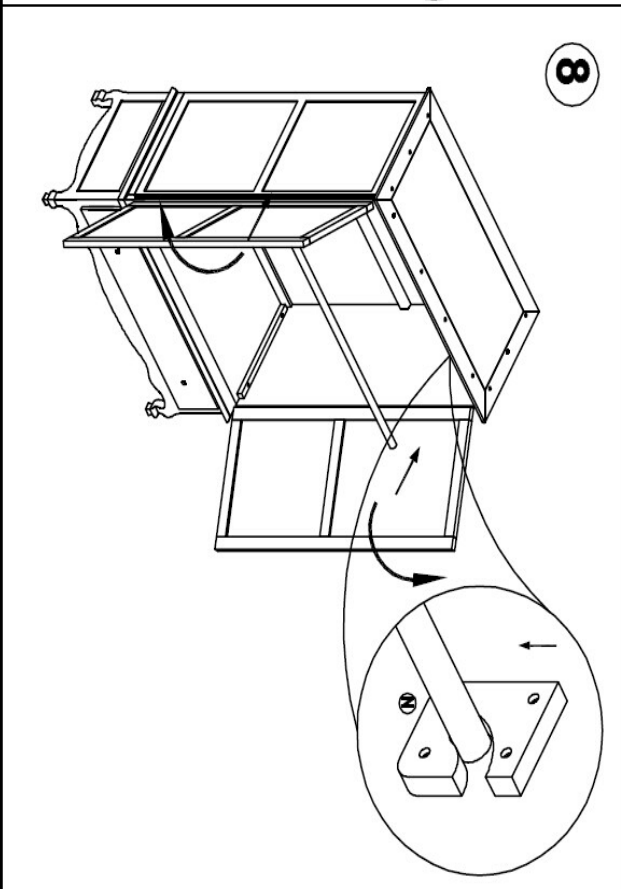
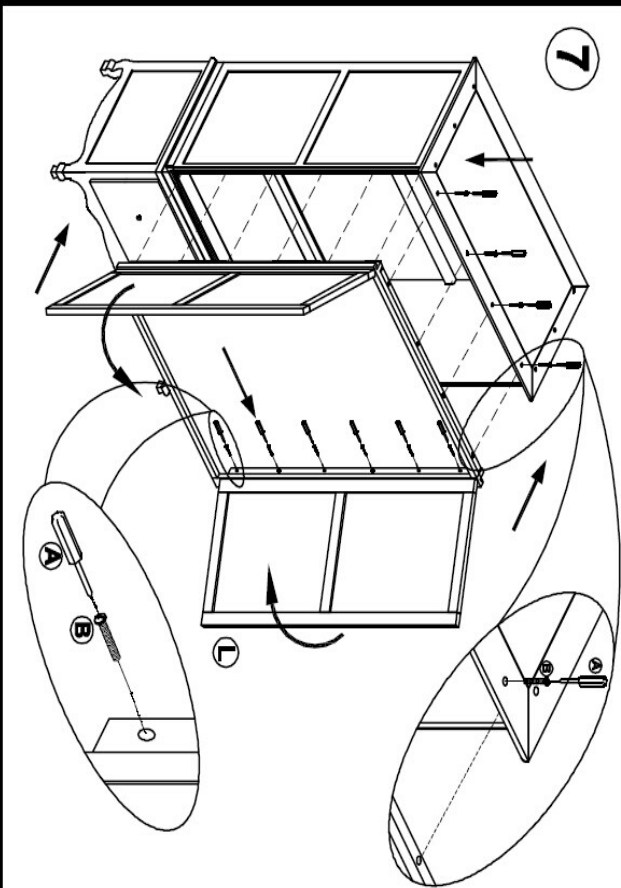
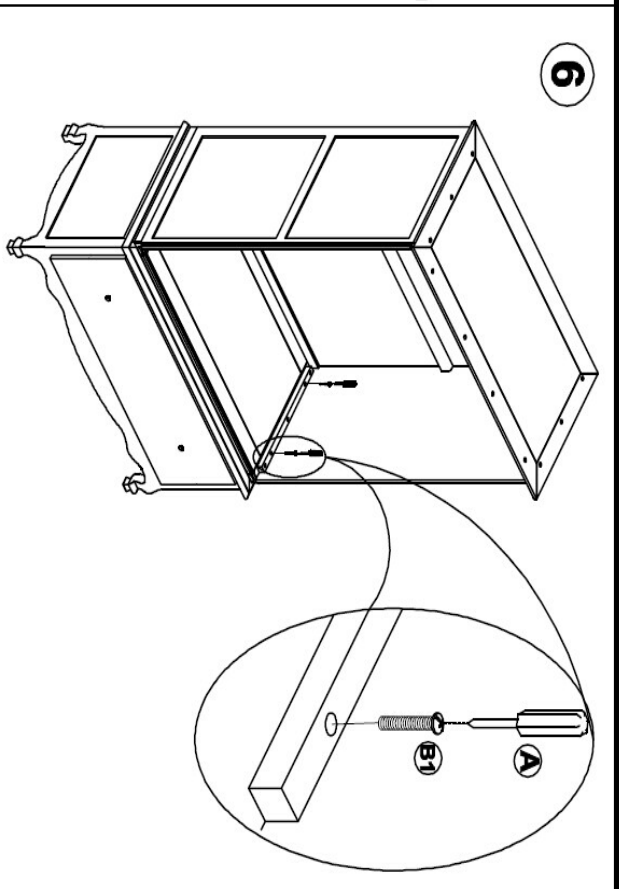
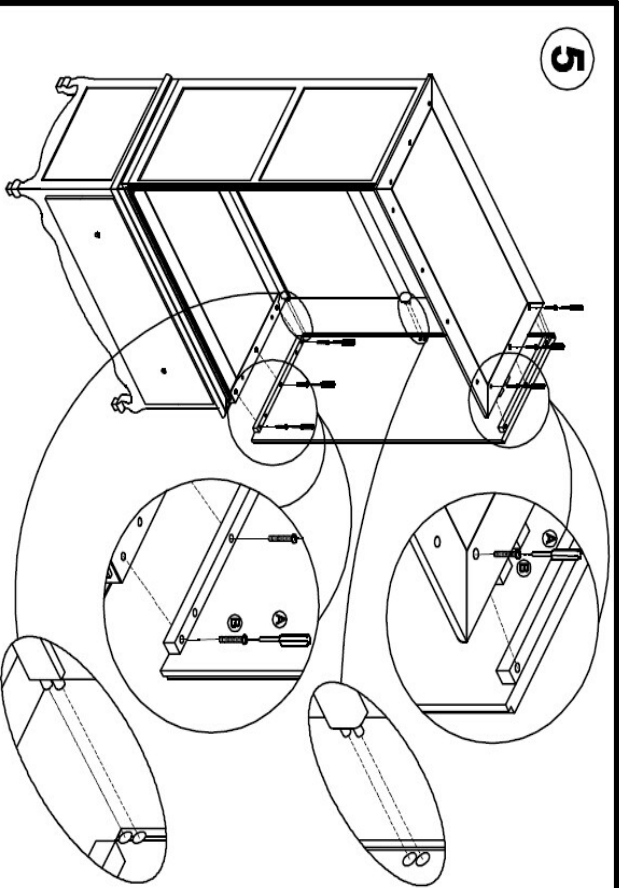

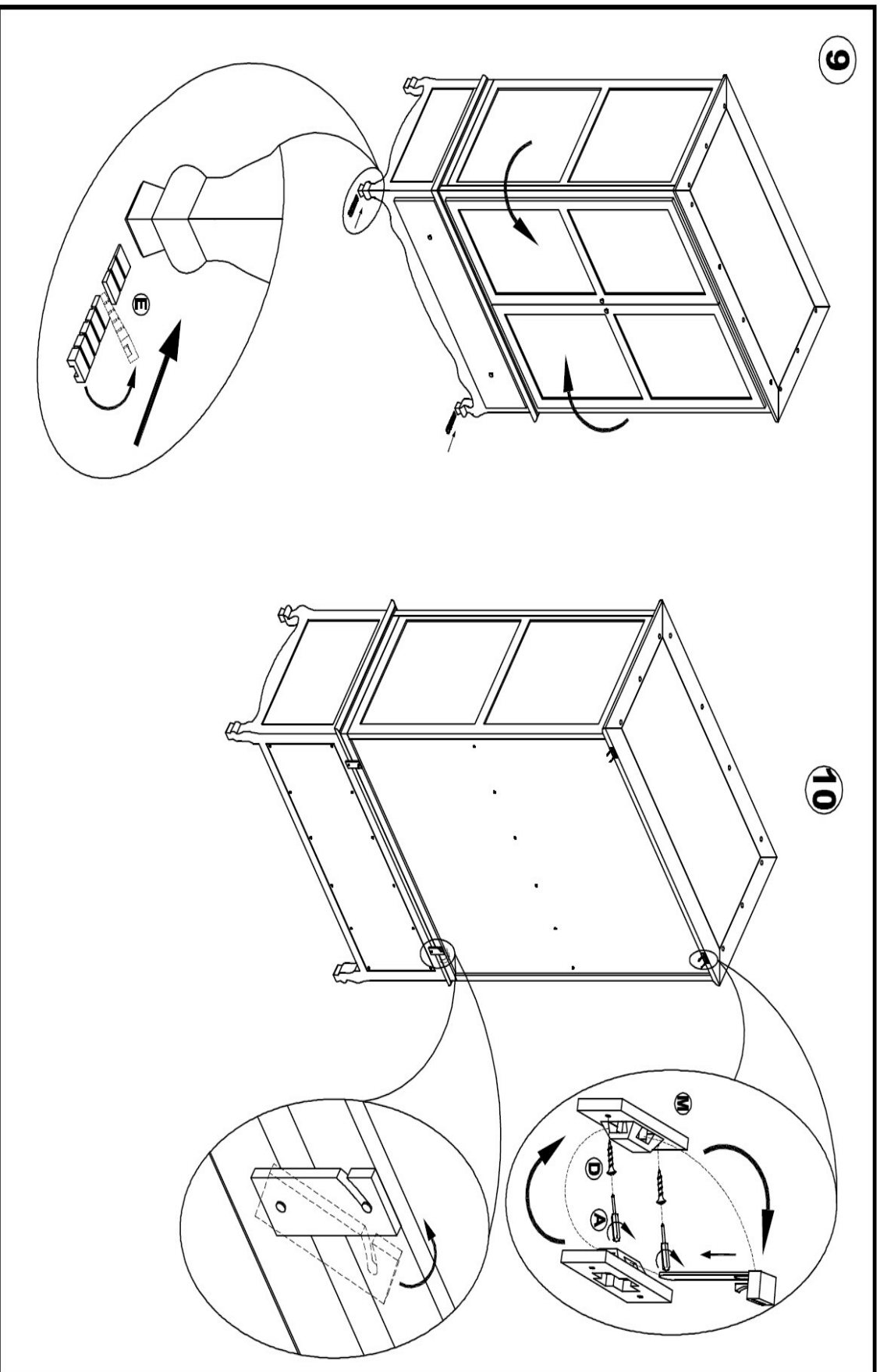

NOTE: IF THE UNIT IS NOT LEVEL, PLACE A LEVELER UNDERNEATH ONE FOOT UNTIL THE UNIT IS LEVEL. BREAK OFF ANY PROTRUDING SEGMENTS

Note: Different wall materials require different types of fixing devices. Use fixing devices suitable for the walls in your home (not included). If you are uncertain about what type of screw or fitting to use, please contact your hardware store.