

feather & black















## **Sienna Bedstead**

**IMPORTANT READ CAREFULLY – RETAIN FOR FUTURE REFERENCE**

Thank you for buying the Sienna Bedstead

### **PRODUCT CARE**

- Wipe clean using a soft damp cloth followed by dry cloth
- Do not use abrasives or cleaning products which may contain ammonia or solvents
- Take care when handling or moving the furniture. Careless handling can damage wooden furniture, try to lift rather than drag
- The fabric is dry clean only and spot clean only

	PARTS	Q'TY
A		1PC
B		1PC
C		2PCS
D		2PCS
E		1PC
F	 Ø10*40mm	8PCS
G	 φ3/8"*80mm	4PCS
H	 (M8*40)	8PCS
I	 (184mm)	2PCS
J	 (198mm)	2PCS
K		1PCS
L	 (Ø10)	8PCS
M		4PCS
N	 8M	4PCS
O	 (M6)	1PC

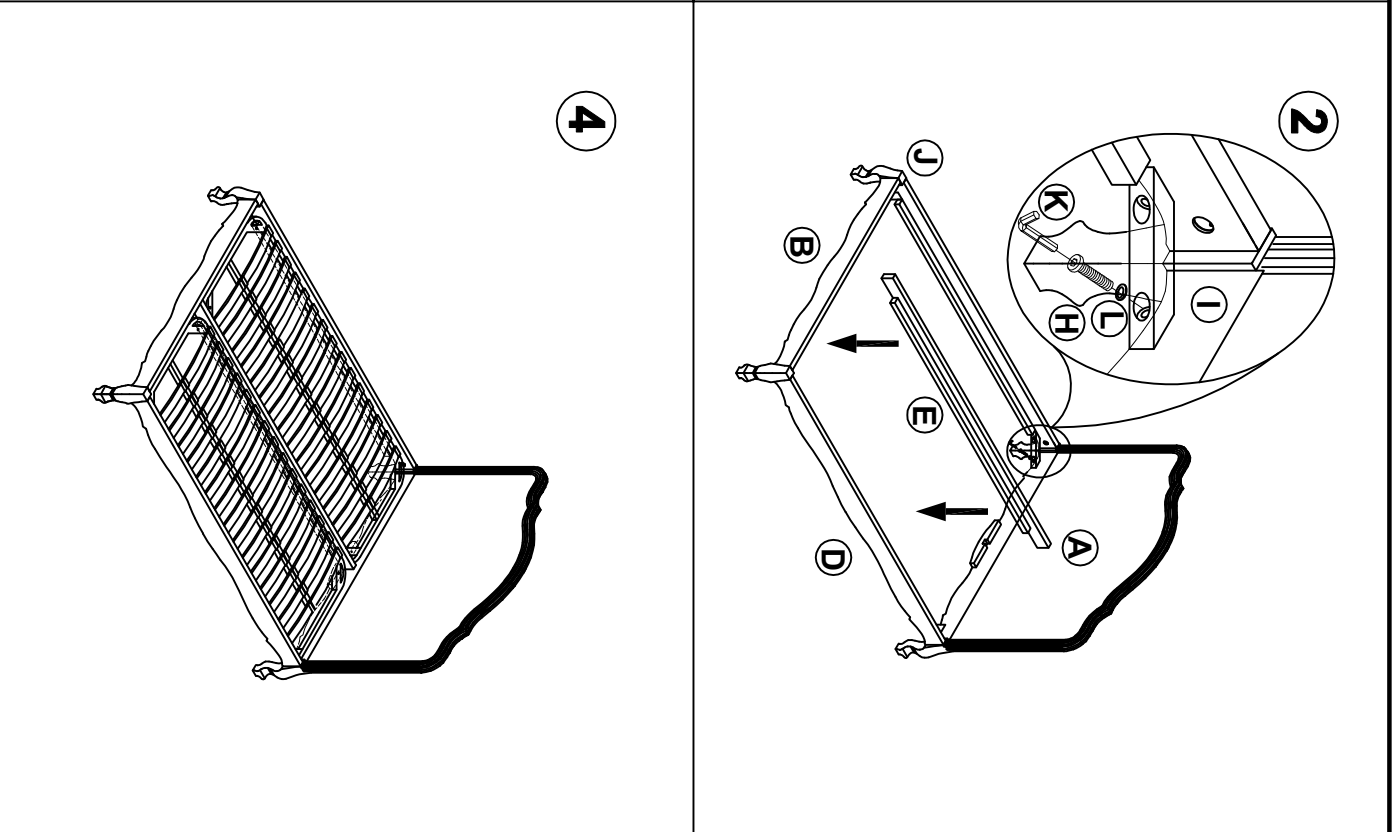
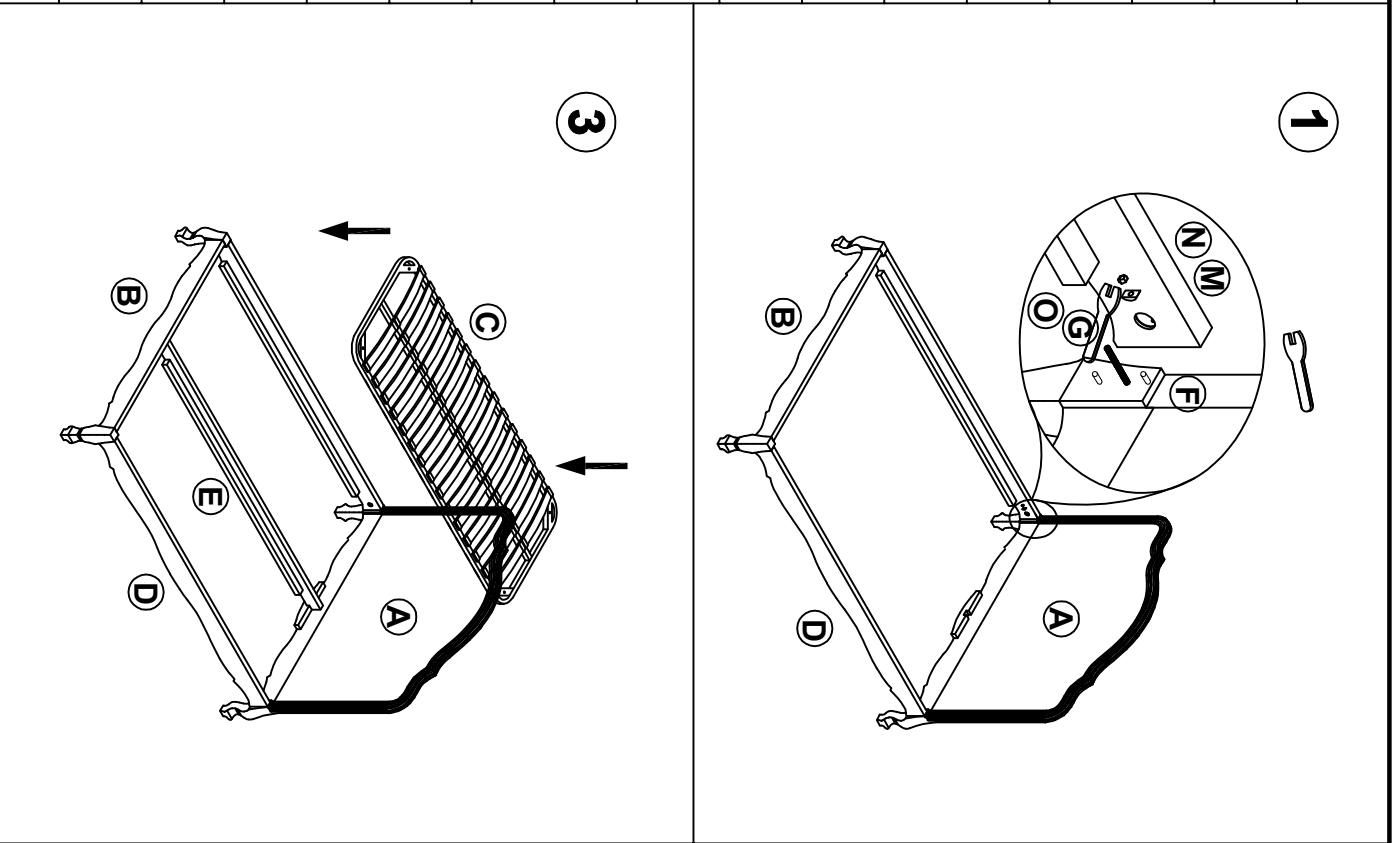

DO NOT MOVE THE BED  
IF WITHOUT SLATS