

*Bedrooms by*  
**feather & black**

# Marblehead Double Wardrobe

IMPORTANT READ CAREFULLY – RETAIN FOR FUTURE REFERENCE

## Thank you for buying the Marblehead Double Wardrobe

- Please take a few quiet minutes to read these instructions
- It is recommended that this product is assembled by two adults
- This product contains small parts, keep small children clear of the assembly area
- Lay out the parts on a clean, flat surface and compare with the parts checklist. Save all packaging until assembly is complete to avoid accidentally discarding fittings

## PRODUCT SAFETY

- All assembly fastenings should always be tightened properly and care should be taken that no fittings are loose











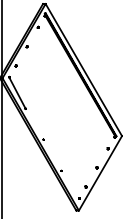

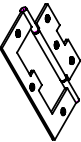

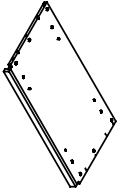



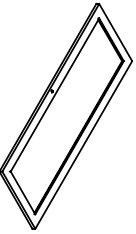
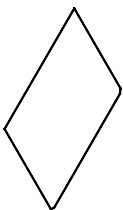

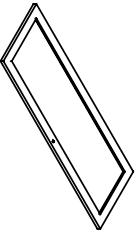
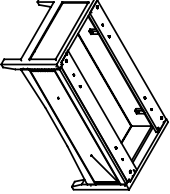
## PRODUCT CARE

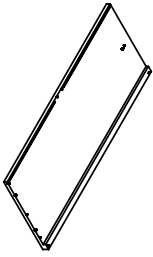
- Wipe clean using a soft damp cloth followed by dry cloth
- Do not use abrasives or cleaning products which may contain ammonia or solvents
- Take care when handling or moving the furniture. Careless handling can damage wooden furniture, try to lift rather than drag
- Colour may vary due to this being a natural product.

## TOOLS REQUIRED

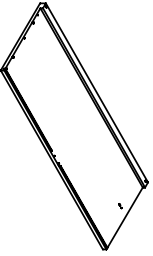
Please use Philips Head Screwdriver (not included) to assemble the wardrobe.



	PARTS	QTY		PARTS	QTY		PARTS	QTY		PARTS	QTY
A		1	G		1	a		6	k		4
B		1	H		1	c		8	l		8
C		1	I		2	e		4	n		18
D		1	J		1	g		2	p		3
E		1	L		1	y		2	s		8
F		1	J		1	t		36			
									v		4

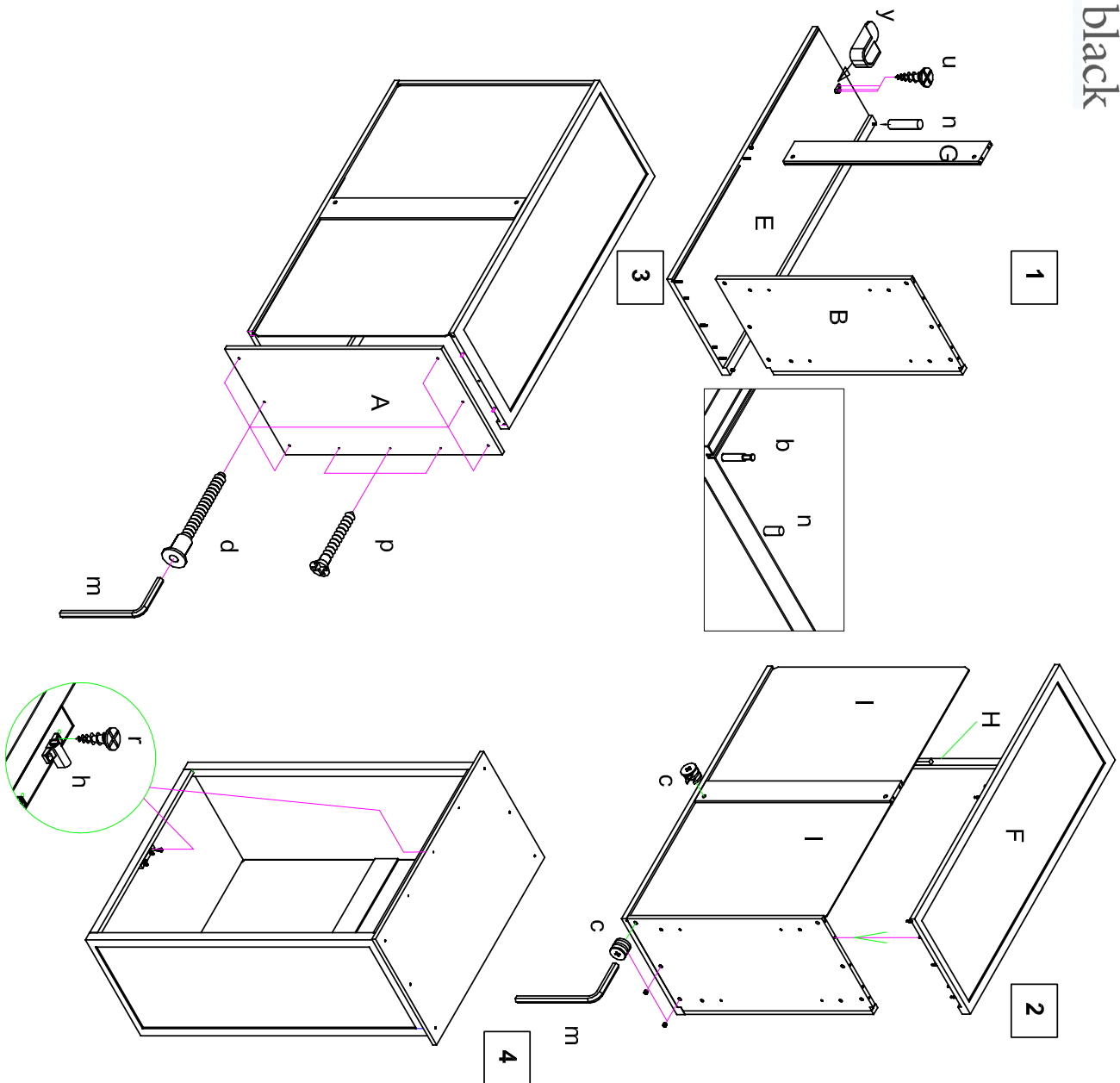

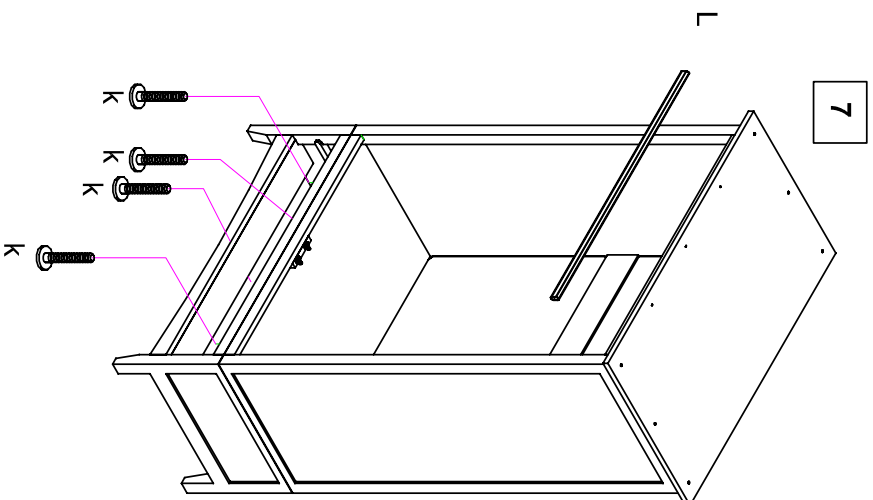
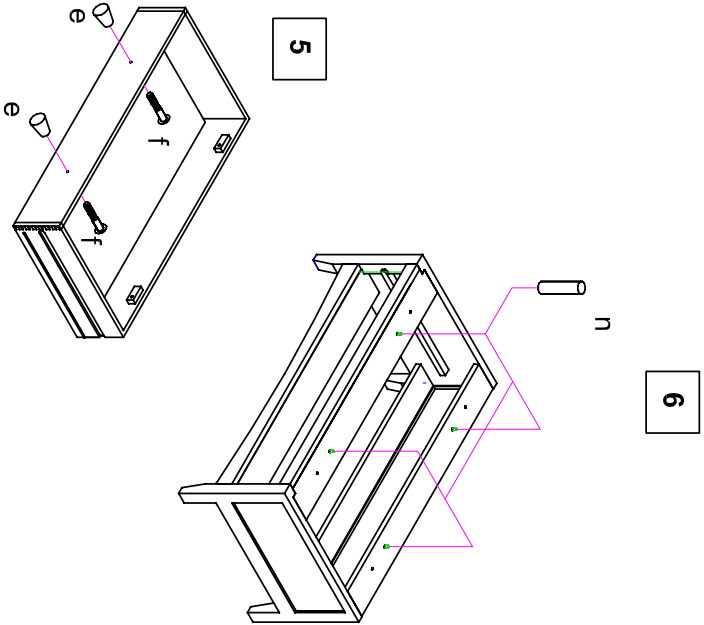

8

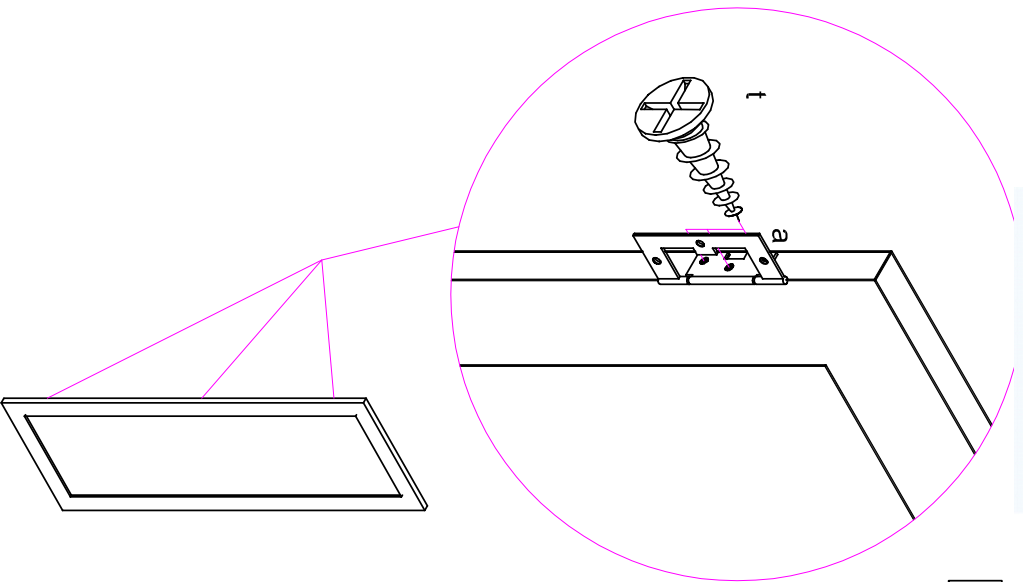

9

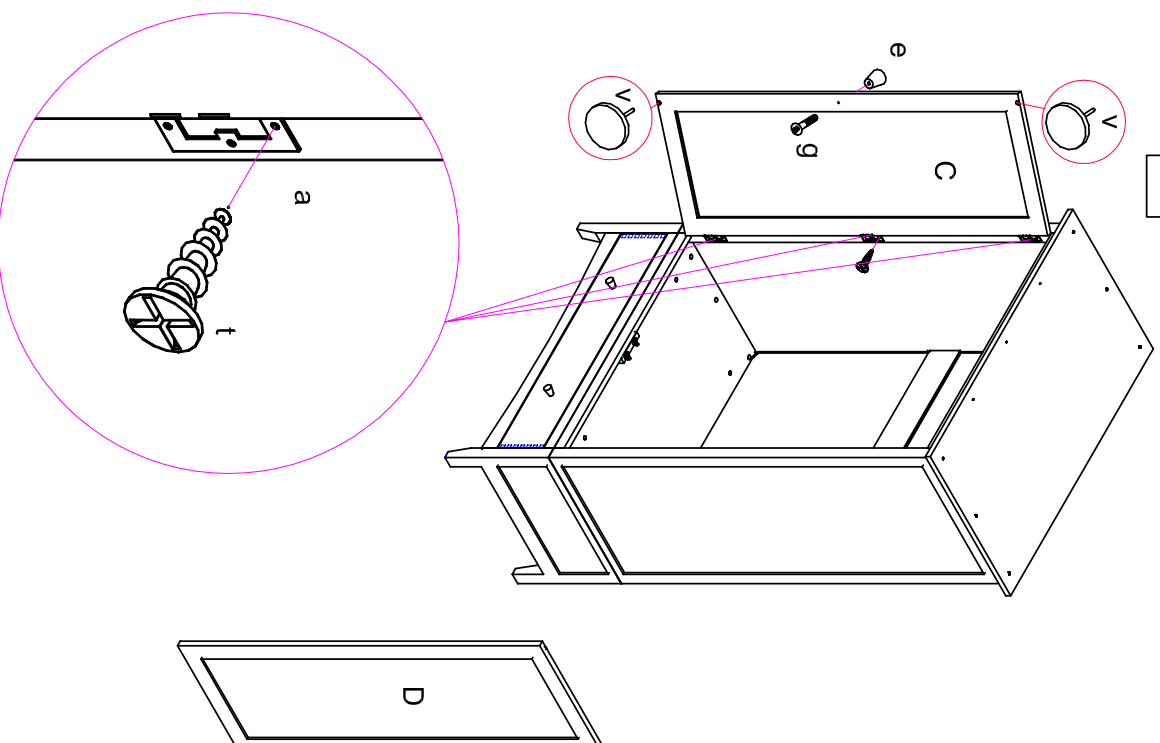

6

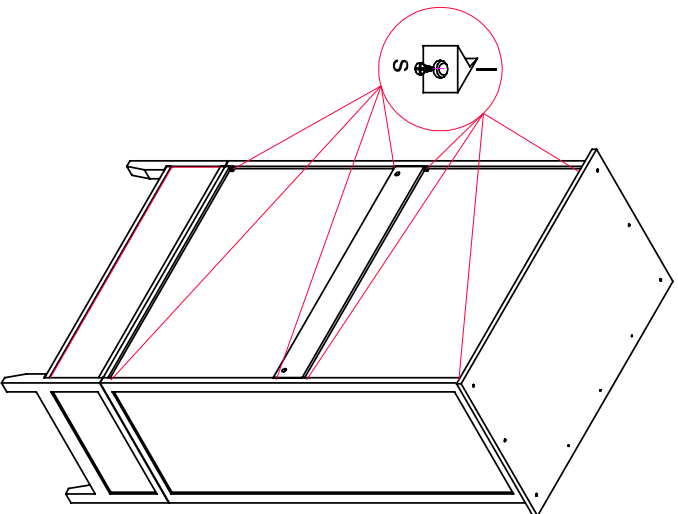

6

