

Henley King Bed Assembly Instructions

Pre-assembly Preparation

Please read these instructions fully prior to assembly to familiarise yourself with the various stages of construction. Carefully open all packs supplied and check the contents against the parts and fittings check list.

Do not destroy any of the packaging until you are certain that you have all the necessary parts for the assembly.

This item is heavy once assembled. Please try to assemble the item as close as possible to the point of use. Take care when moving the item to avoid personal injury or damage to the product and always lift rather than drag.

There are small components used in the construction of this bed as well as plastic foil packaging, these should be kept away from young children whilst assembling your bed.

This product requires a minimum of 2 people to assemble.

Product Safety

All assembly fastenings should always be tightened properly and care should be taken to ensure that no fittings are loose.

Periodically check and ensure that all components are in their proper position, free from damage, and that all connectors are tight.

Once the bed is assembled, do not sit, stand or apply weight directly to the slats unless the mattress is in place.

Product Care

To clean, slightly moisten cloth with water and wipe surfaces. A damp cloth holds dust and prevents damage. repeat with a dry, soft, lint-free cloth.

Do not use abrasives or cleaning products which may contain ammonia or solvents











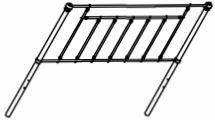

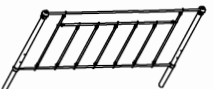

Tools Required:

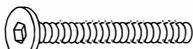
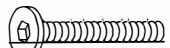
Please use an Allen key & Spanner

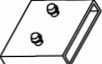

If you require any advice during assembly please call our customer service team on 01243 380600.

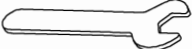
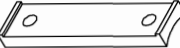
feather & black

	PARTS	QTY	Q		4PCS
A		1PC	R		4PCS
B		1PC			
C		2PCS			
D		1PC			
E		2PCS			
F		24PCS			
G	 M6x63mm	2PCS			
H	 M6x38mm	4PCS			
I	 M6x25mm	8PCS			
J		6PCS			
K		24PCS			
L		12PCS			
M		1PC			
N		1PC			
O		4PCS			
P		4PCS			

1

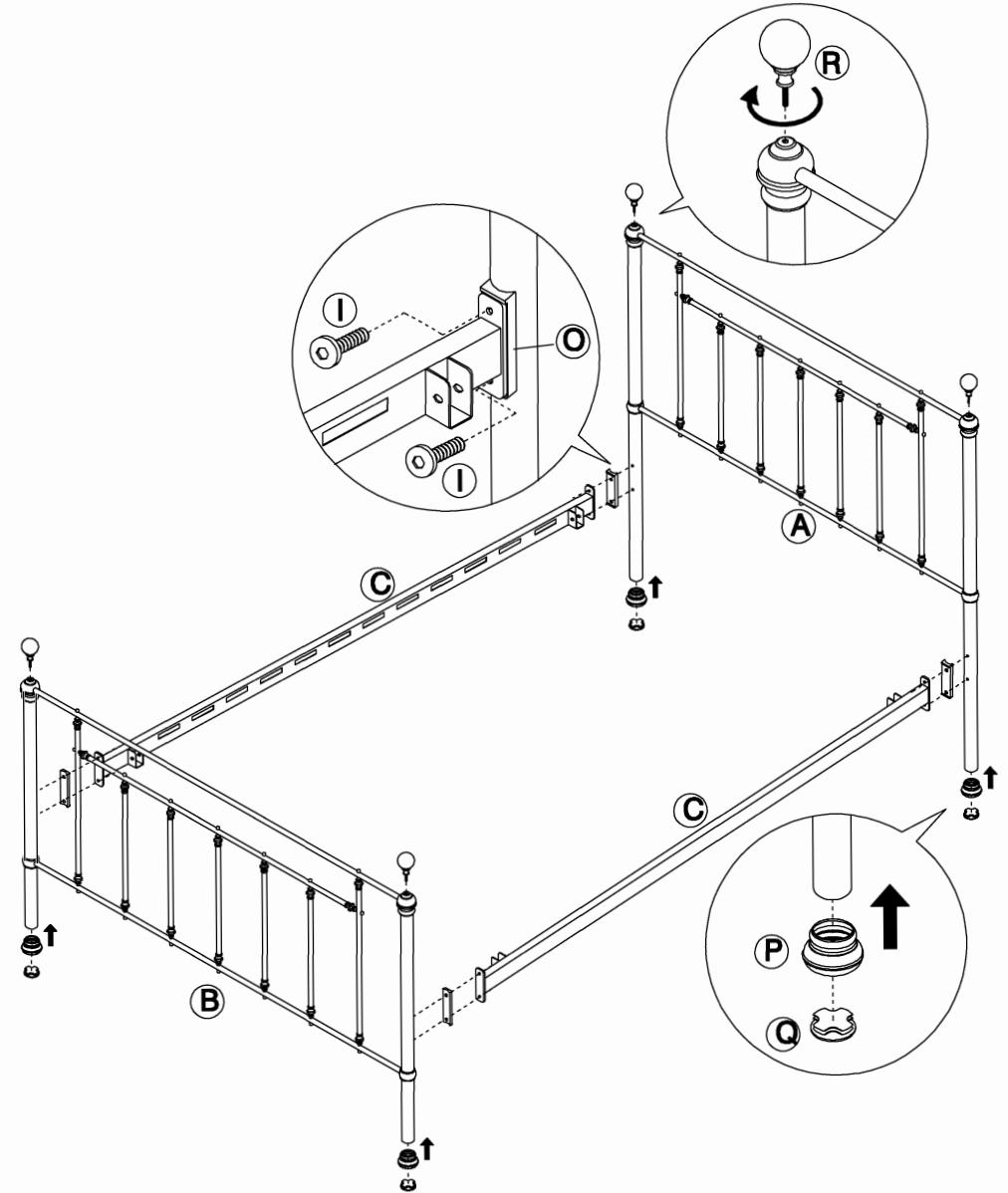

2

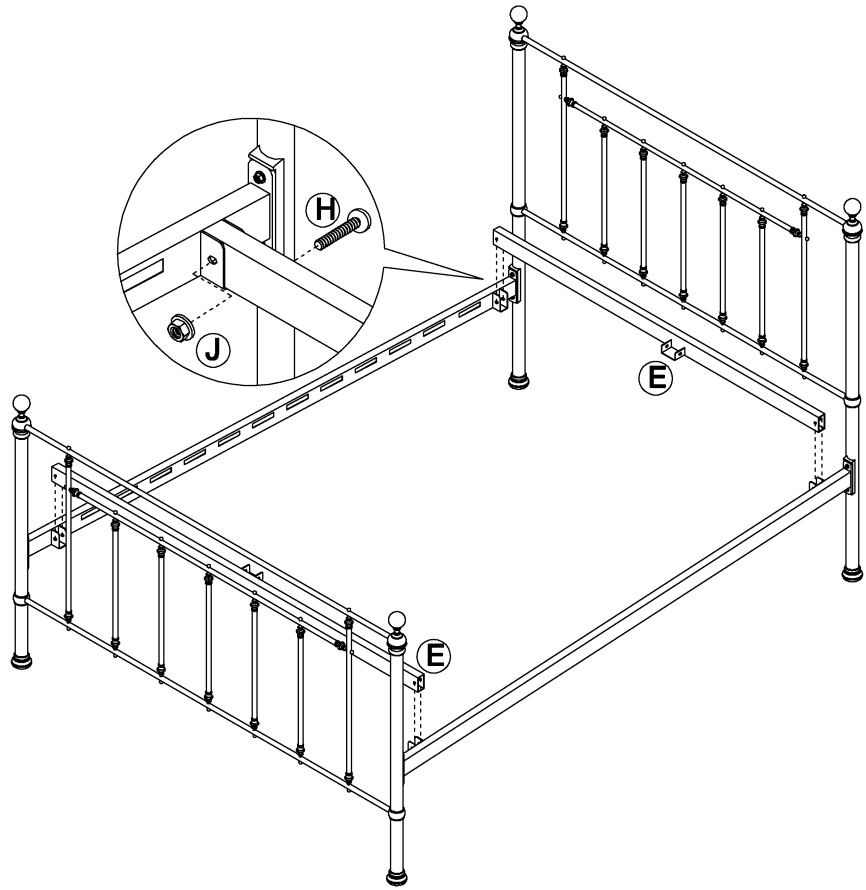

3

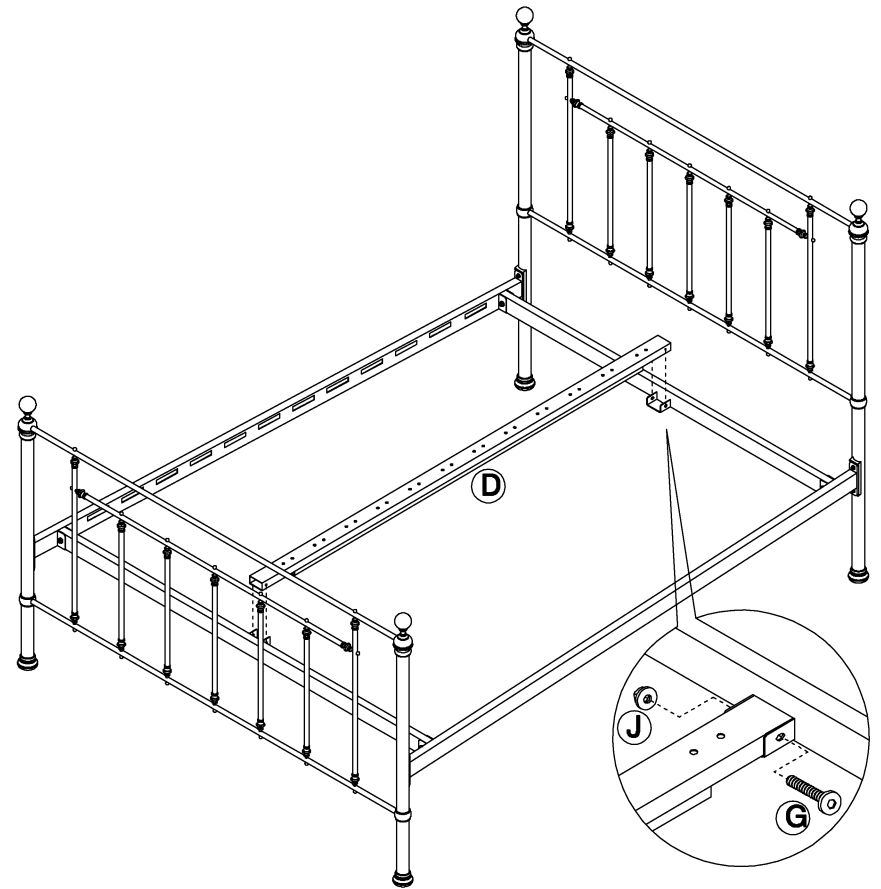

feather & black

4

