

## **BEAUMONT Standard Bedstead Super King**









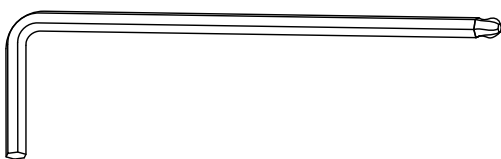
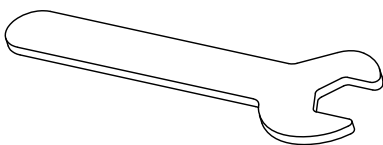

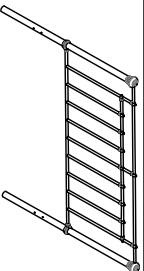

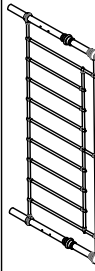

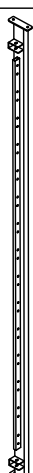

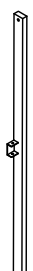
### **IMPORTANT READ CAREFULLY - RETAIN FOR FUTURE REFERENCE**

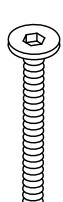
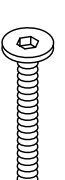
- Read all instructions before assembly. KEEP INSTRUCTIONS FOR FUTURE USE
- Save all packing materials until assembly is complete to avoid accidentally discarding fittings
- All assembly fastenings should always be tightened properly and that care should be taken that no fittings are loose
- To clean, slightly moisten cloth with water and wipe surfaces. A damp cloth holds dust and prevents damage. Repeat with a dry, soft, lint-free cloth
- Do not use abrasives or cleaning products which may contain ammonia or solvents
- Once bed is assembled, do not sit, stand or apply weight directly to slats unless mattress in place.
- This product is HEAVY, so it must be assembled with at least 2 PEOPLE.

### **TOOLS REQUIRED:**

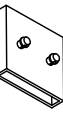
- Please use Spanner and Allen key



	PARTS	QTY	P	
			Q	R
A		1PC		4PCS
B		1PC		4PCS
C		2PCS		4PCS
D		1PC		
E		2PCS		
F		30PCS		
G	 M6x63mm	2PCS		
H	 M6x38mm	4PCS		
I	 M6x25mm	8PCS		
J		6PCS		
K		30PCS		
L		15PCS		
M		1PC		
N		1PC		
O		4PCS		

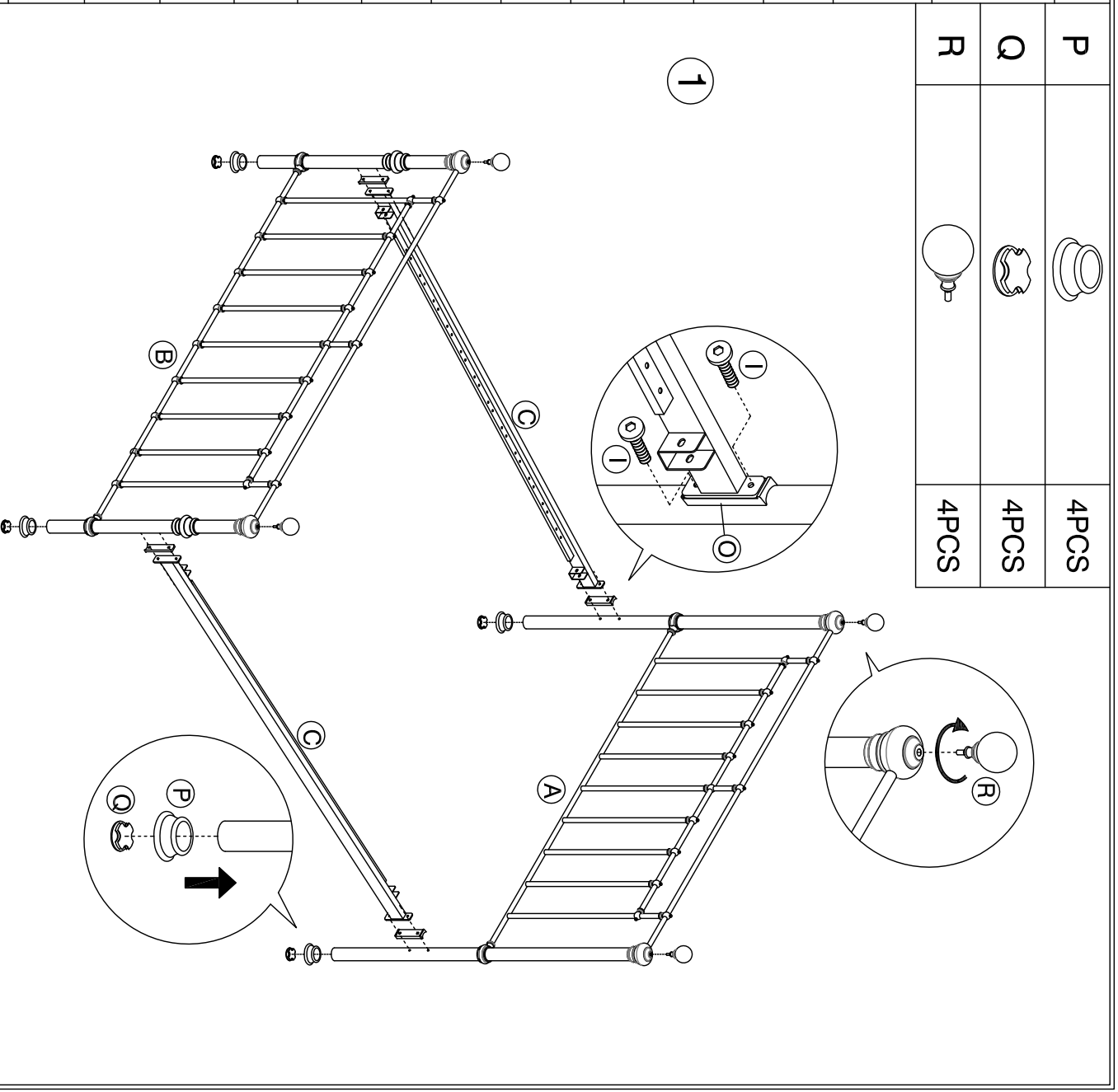

2

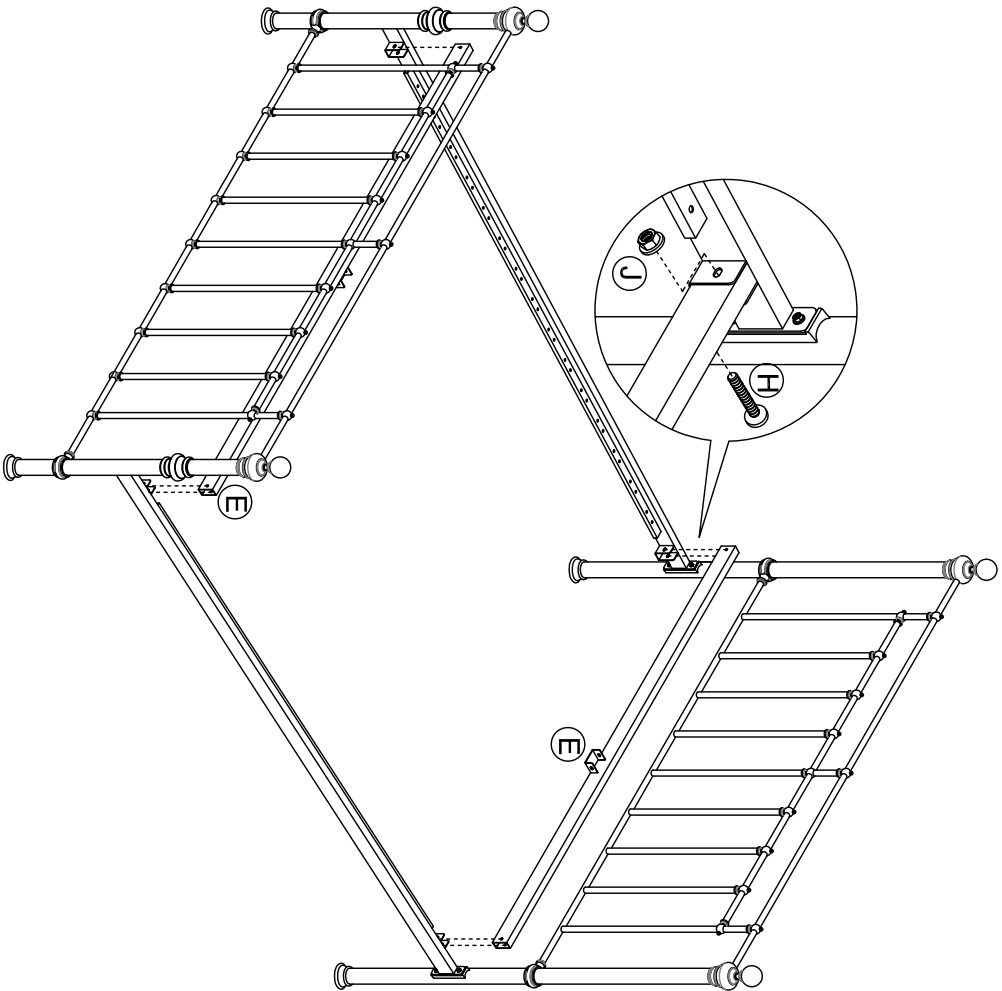

3

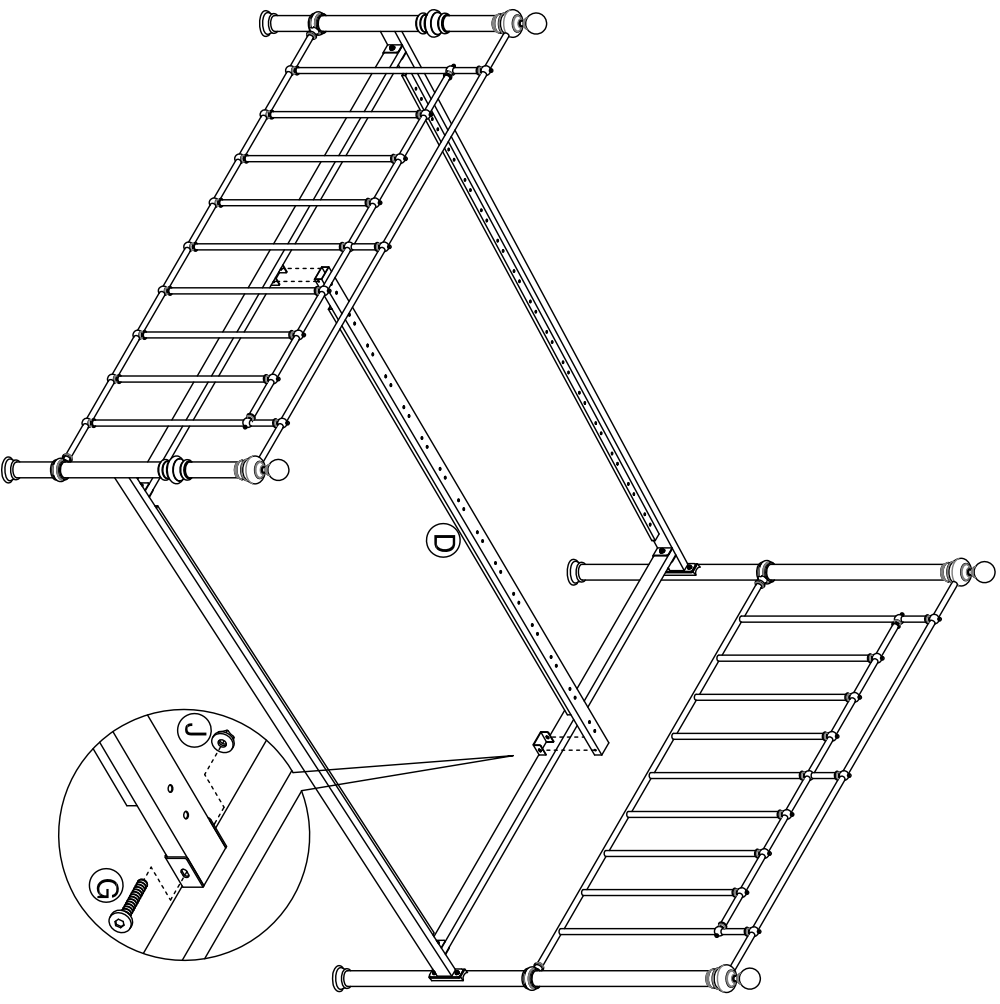

4

