

feather & black

Oliver Bedstead King













IMPORTANT READ CAREFULLY – RETAIN FOR FUTURE REFERENCE

- Read all instructions before assembly. KEEP INSTRUCTIONS FOR FUTURE USE
- Save all packing materials until assembly is complete to avoid accidentally discarding fittings
- All assembly fastenings should always be tightened properly and that care should be taken that no fittings are loose
- To clean, slightly moisten cloth with water and wipe surfaces. A damp cloth holds dust and prevents damage. Repeat with a dry, soft, lint-free cloth
- Do not use abrasives or cleaning products which may contain ammonia or solvents
- Once bed is assembled, do not sit, stand or apply weight directly to slats unless mattress is in place.

TOOLS REQUIRED:

- Please use Allen key



	PARTS	Q'TY
A		1PC
B		1PC
C		2PCS
D		1PC
E		2PCS
F		28PCS
G		2PCS
H	 1/4" x 22	17PCS
I	 1/4" x Ø23 x 2.0	8PCS
J	 1/4" x Ø16 x 1.0	17PCS
K		14PCS
L		28PCS
M	 M4	1PC

1

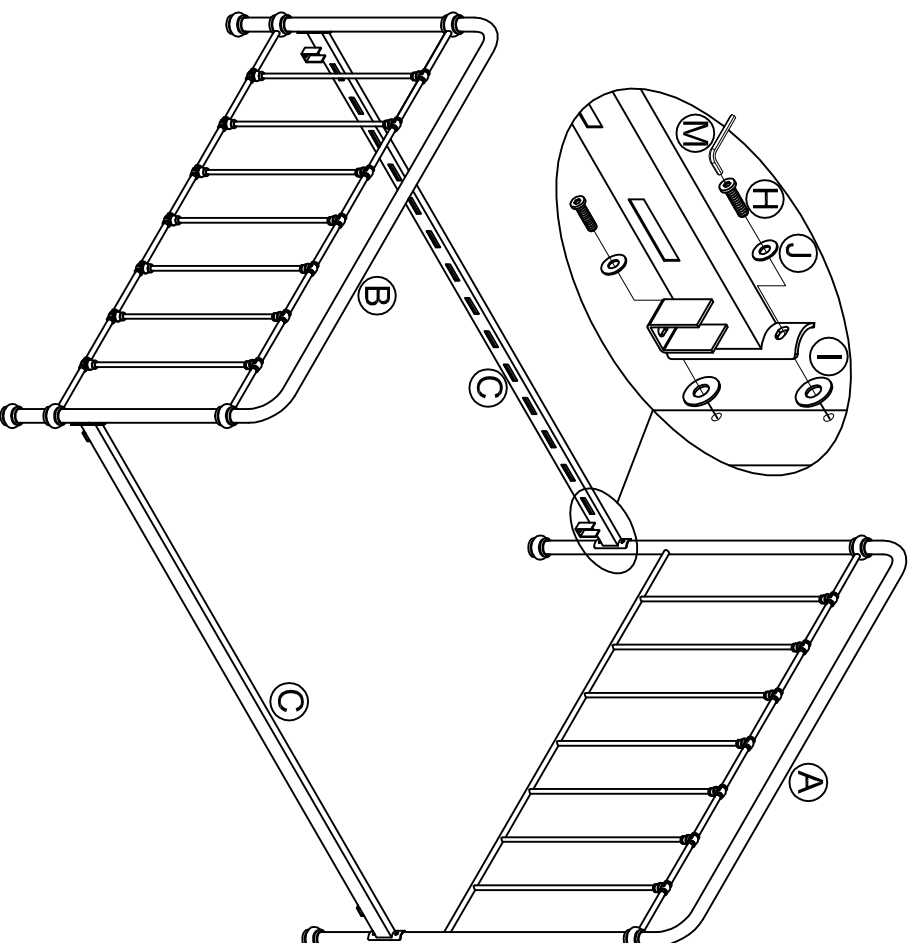

2

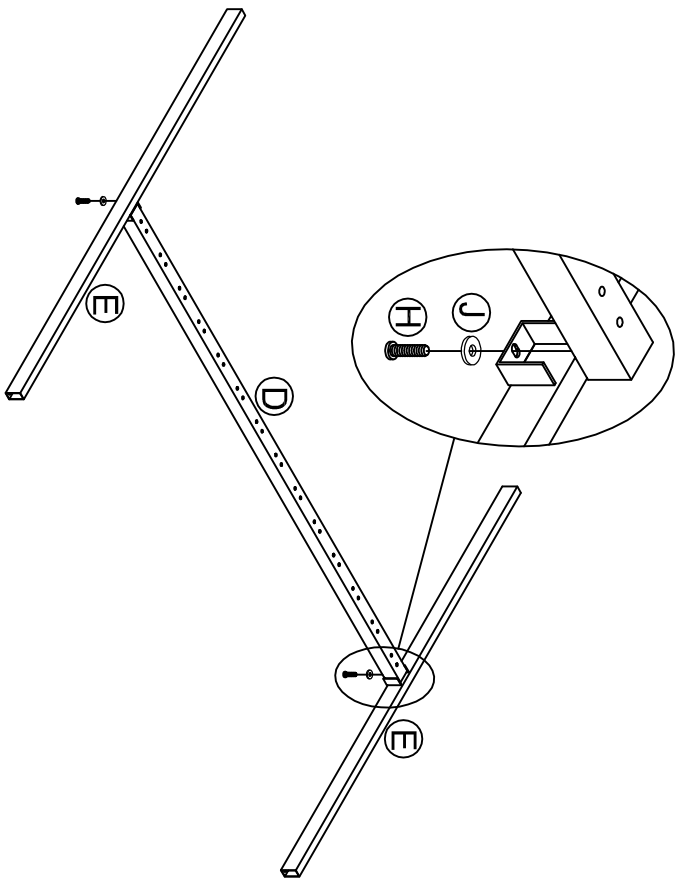

3

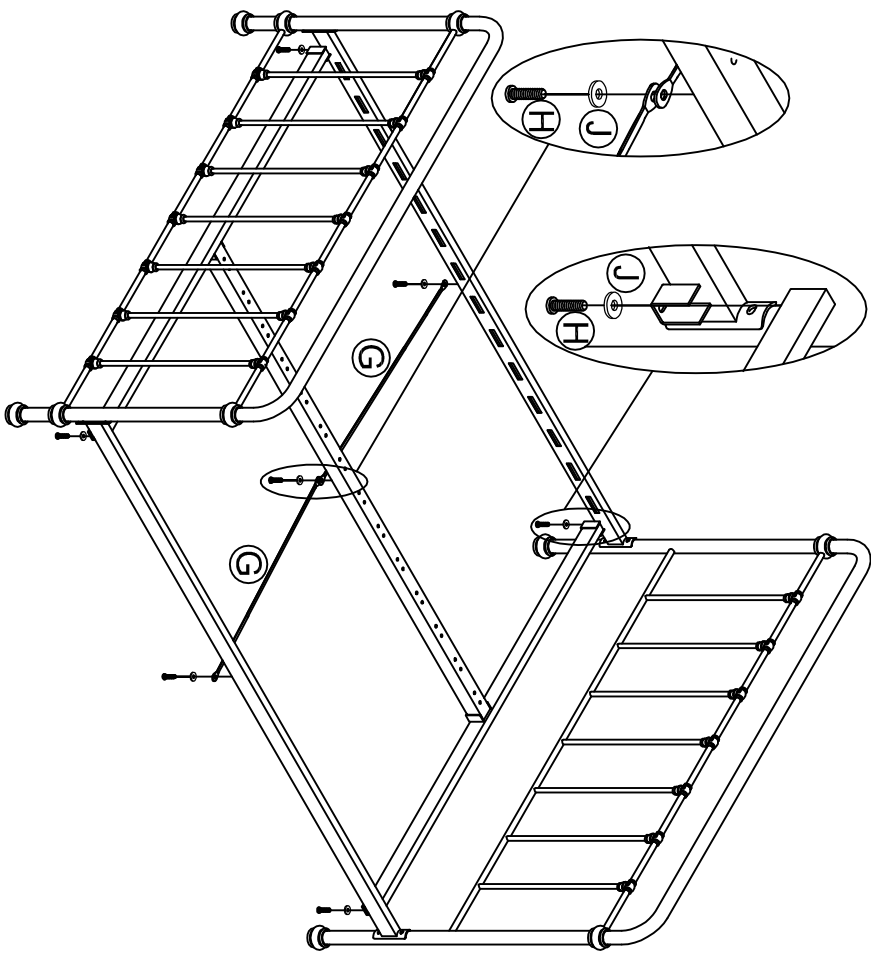

4

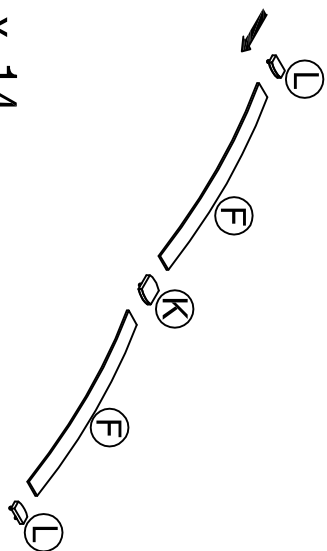

X 14

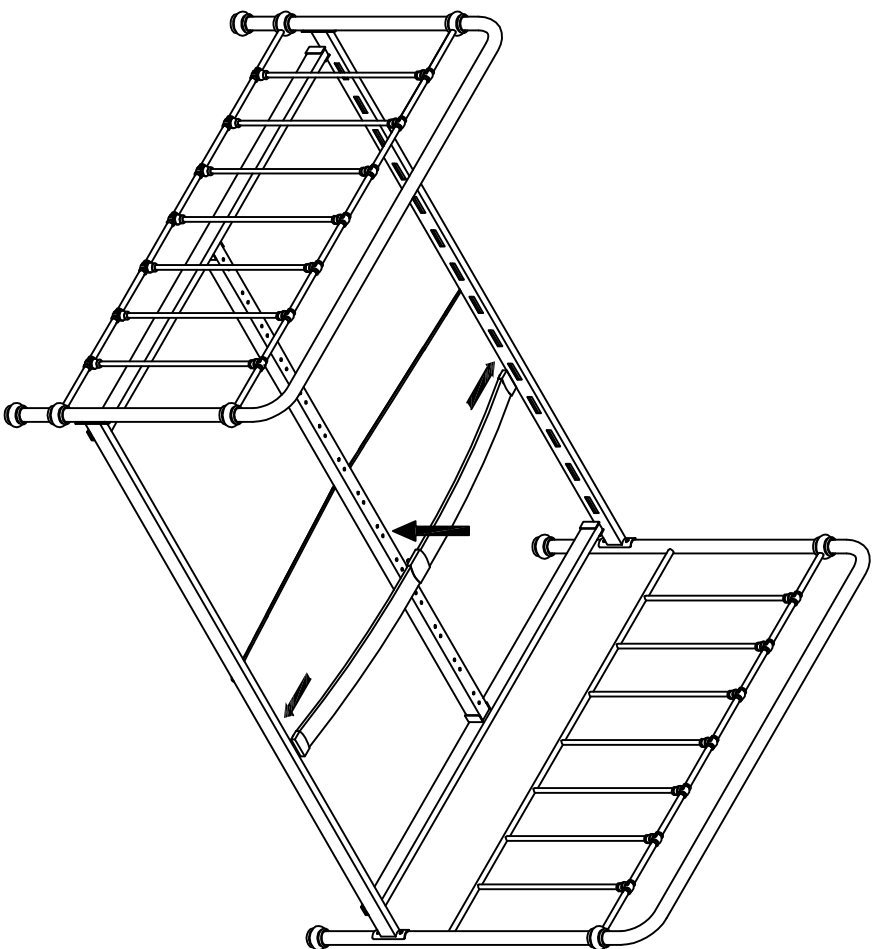

5

